

# ELECTROSTRAINER<sup>®</sup> System



Operation Manual

Models: ES-125 / ES-100



(888) 384-8881  
(952) 475-8084



support@electrosea.com  
www.electrosea.com

**ELECTROSEA<sup>®</sup>**

## Introduction

Table of Contents	2
ElectroSea and ElectroStrainer System	3

## System Features

User Interface	4
Operating Modes and Feature Overview	5-6
Safety Considerations	5
Optimal Performance and Strainer Flow Alert	7

## ElectroStrainer Maintenance

Canister Assembly Access	8
ElectroStrainer Maintenance	9-13
Cell Indicator	14

## System Updates

Factory Default and Firmware Updates	15
--------------------------------------	----

## Inspection

Periodic Inspection	16
---------------------	----

## Important Information

Specifications	17
----------------	----

## Modes and Troubleshooting

Modes, Descriptions and Actions	18-19
---------------------------------	-------

### Warranty Policy

Please visit our website at [www.electrosea.com/warranty](http://www.electrosea.com/warranty) to view our full warranty terms and conditions.

**COPYRIGHT © 2022**

*No part of this publication may be reproduced, translated, stored in a retrieval system, or transmitted in any form or by any means electronic, mechanical, photocopying, recording, or otherwise without the prior written consent of ElectroSea, LLC. Every precaution has been taken in the preparation of this manual to ensure its accuracy. ElectroSea assumes no responsibility for errors and omission. Neither is any liability assumed for damages resulting from the use of this product and information contained herein.*

## ELECTROSEA®

---

ElectroSea was created when the owners of a sportfishing vessel invented “a better way” to prevent biofouling in their seawater cooling system. Solving complex technical problems is our expertise. With more than 100 issued U.S. patents and 350+ foreign patents in advanced technologies, our executive management team has been developing innovative solutions for more than 50 years. With an expert team of “old salts” who eat, sleep, and breathe boating, ElectroSea will improve your time on the water.

## ELECTROSTRAINER® System

---

ElectroStrainer is a revolutionary seawater biofouling prevention device, a sea strainer, and a smart seawater flow-monitoring unit all combined into a single system. ElectroStrainer provides an entirely new way for boaters to prevent biofouling, barnacles, and bioslimes from clogging sea strainers and seawater pipes for air conditioners, chillers, and refrigerators. ElectroStrainer provides ease of use never seen before in a sea strainer and completely redefines seawater system maintenance.

- **ElectroStrainer is a Biofouling-Prevention Device:** ElectroStrainer continuously creates a safe and effective low level of chlorine to protect the entire seawater system. ElectroStrainer contains a Cell with a proprietary mixed metal-oxide coating. When electrified, it acts as a catalyst to generate chlorine naturally from the seawater passing through it. No chemical additives are required.
- **ElectroStrainer is a Sea Strainer:** Typical sea strainers become clogged as bioslime, algae, and barnacles build up over time in the strainer basket pores. ElectroStrainer solves this problem by preventing unwanted marine growth by generating chlorine directly inside its sea strainer basket. Strainer pores remain open, free, and clear so protected seawater can pass downstream to cooling equipment and decrease the frequency of strainer-basket cleaning.
- **ElectroStrainer is a Smart Seawater Flow-Monitoring System:** ElectroStrainer provides real-time monitoring with Smart Strainer Alert technology and automatically notifies you to check the strainer if it requires attention. ElectroStrainer monitors vessel seawater flow 24/7/365 days a year and displays the seawater flow rate in real time.

## User Interface

### Features and Functions

1. Power ON ElectroStrainer. The Control Unit will complete a diagnostic self-test, and then the green “POWER” light will be illuminated.
2. The main status screen will be displayed.

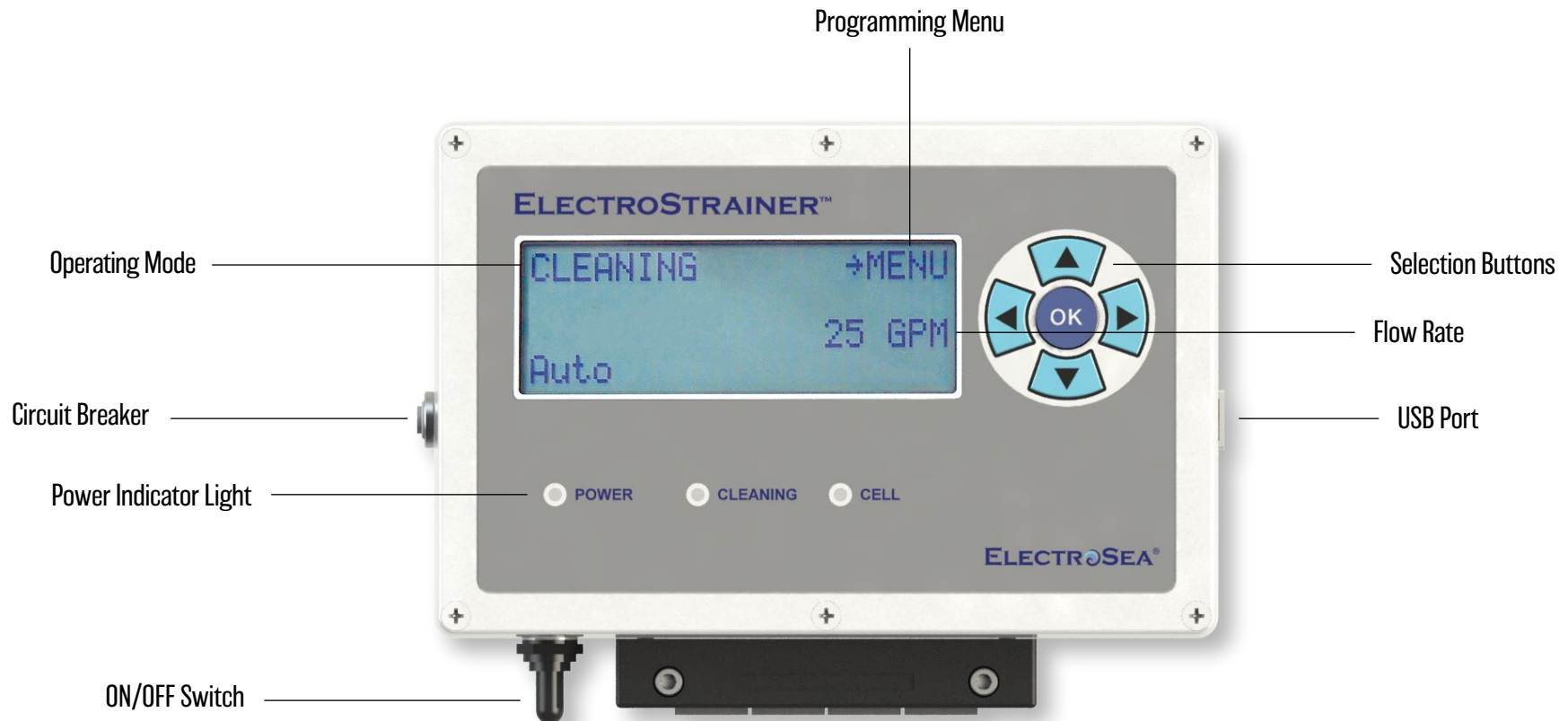

## Operating Modes

The Operating Mode displays the state of the ElectroStrainer System. Modes include

- **OFF:** ElectroStrainer is powered, but it is in the OFF mode and not Cleaning.
- **START-UP:** ElectroStrainer is performing a diagnostic self-test. This mode lasts for approximately 30 seconds.
- **CLEANING:** ElectroStrainer is ON and Cleaning. This is the normal operating mode for the ElectroStrainer System.
- **STRAINER FLOW ALERT:** ElectroStrainer is ON and Cleaning, but the flow rate measured is less than or equal to the value set manually in the Flow Alert feature.
- **CELL INDICATOR:** ElectroStrainer is sensing low salinity (brackish or fresh water), high resistance, or disconnection of the Cell Cable. This indicator may also mean the Cell is at the end of its useful life.

## Feature Overview

- **Flow Rate (GPM):** The flow rate is monitored in gallons per minute (GPM) or liters per minute (LPM) at the output of the ElectroStrainer System.
- **Strainer Flow Alert:** The Strainer Flow Alert indicates the strainer basket has debris and/or the flow rate is at or below a threshold level for a period of time.
- **Display Contrast, Backlight, and Imperial/Metric Units:** Use this feature to adjust the LCD display contrast and backlight levels from Lo to Hi and to select between imperial and metric units for flow in GPM or LPM.
- **Default Update:** This process is used to restore ElectroStrainer to its original factory default settings or to update the ElectroStrainer Control Unit firmware using a USB memory drive supplied by ElectroSea.

## Safety Considerations

**WARNING** Indicates a hazardous situation that, if not avoided, could result in death or serious injury.

**CAUTION** Indicates a hazardous situation that, if not avoided, could result in minor or moderate injury.

**NOTICE** Indicates a hazardous situation that can cause damage to personal property, the environment, or equipment.

**WARNING** **DO NOT PERFORM ACID DESCALING OF THE SEAWATER CIRCUIT AFTER THE ELECTROSTRAINER SYSTEM HAS BEEN INSTALLED. DESCALING ACIDS OR CLEANING CHEMICALS WILL DAMAGE THE CELL AND CANISTER AND VOID THE WARRANTY.**

## Power ON and Start-Up Delay

Power ON the ElectroStrainer System. The Control Unit will complete a diagnostic self-test, and then the green “POWER” LED will be illuminated. “START-UP” will be displayed for 30 seconds.

## Cleaning Mode

During normal operation the Control Unit will flash “CLEANING,” and the green Cleaning LED will be illuminated. This indicates the ElectroStrainer System is electrochemically generating chlorine to prevent biofouling. The Control Unit will display the seawater flow rate at the output of the ElectroStrainer System in gallons per minute (GPM) or liters per minute (LPM). If the flow rate drops below 4 GPM (15.1 LPM), the display will indicate “MIN FLOW”. The ElectroStrainer System will automatically stop chlorinating seawater if Min Flow (1-3 GPM/3.8-11.4 LPM) or No Flow (0 GPM) is reached.



## Auto Mode

The ElectroStrainer System automatically and continuously calculates the optimal level of chlorinated seawater to prevent biofouling using multiple input parameters, including seawater flow rate, key electrical parameters, and environmental temperature.

## Display Backlight, Contrast and Imperial/Metric Units

**Set Backlight, Contrast, or Units:** The LCD display backlight, contrast, and imperial/metric units can be set. Use the Up or Down arrows to select and change the settings.

## Optimal Performance

**Constant Chlorinated Seawater Flow:** The ElectroStrainer System should be powered ON and have seawater flowing through it whenever possible. This provides the vessel's seawater circuit with constant chlorinated seawater to prevent unwanted marine growth. Intermittent or stagnant seawater that is not continuously electrochemically treated allows growth of marine microorganisms. Barnacles have the innate ability to close themselves off and survive intermittent exposure to biocidal agents:

- DO NOT turn off seawater pumps, air conditioners, or chillers for an extended period of time.

Inspect the vessel for problem areas:

- Pre-existing biofouling in seawater lines prior to ElectroStrainer installation
- Clogged seawater intakes
- Impacted, blocked, or occluded lines from debris lodged in plumbing
- Sporadic demand valve areas (Depending on the system, valves that turn on and off can foster unwanted marine growth.)

## Strainer Flow Alert

**Strainer Flow Alert:** The Strainer Flow Alert feature monitors seawater flow through the ElectroStrainer. This smart strainer system notifies the user if the ElectroStrainer basket contains debris, such as seaweed or mud; or part of the seawater circuit, such as the intake screen or thru-hull fitting, is partially blocked; or the seawater pump is producing low flow and requires maintenance. The Strainer Flow Alert feature allows the user to set a minimum seawater flow rate threshold value and time duration. If the seawater flow rate drops below the minimum value for a period of time, "CHECK STRAINER / FLOW ALERT" will flash on the display (no audible alert). Flow rate can be set in GPM or LPM, with the time duration set in minutes. To set the Strainer Flow Alert value, go to Menu, Flow Alert and enter the desired threshold flow rate and time duration for notification.

**NOTICE** The Strainer Flow Alert feature is OFF by default and must be set up by the installer or end user.

**NOTICE** ElectroStrainer will continue generating chlorine even after a Strainer Flow Alert occurs.

If a Strainer Flow Alert occurs

1. Check vessel's intake screens for blockage or debris.
2. Check seawater pump output, impeller, or other causes of low flow.
3. Check ElectroStrainer basket for debris, seaweed, or mud.

>	-Flow Alert	-Update
	-Display	
	-Cell Mt	
	-Default	-Exit

## Canister Assembly Access

Before accessing the Canister Assembly, power OFF the ElectroStrainer Control Unit.

### To Access the Canister Assembly:

1. Power OFF the ElectroStrainer Control Unit.
2. Turn OFF ALL seacock valves in the seawater circuit at or below the waterline. This includes any output seacocks to prevent back siphoning.

**WARNING** Failure to turn OFF ALL seacock valves in the seawater circuit could result in sinking the vessel.

3. Locate the 1' (30.5-cm) cable labeled "CELL" that is located at the top of the Canister Assembly. Disconnect this cable at the cable connector.

**NOTICE** DO NOT UNSCREW THE TWO BLACK PLASTIC CAP NUTS ON TOP OF THE LID OR TITANIUM HARDWARE UNDER THE LID.

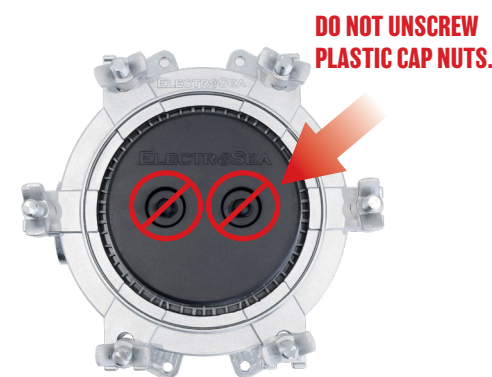
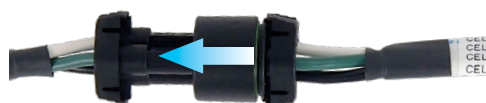
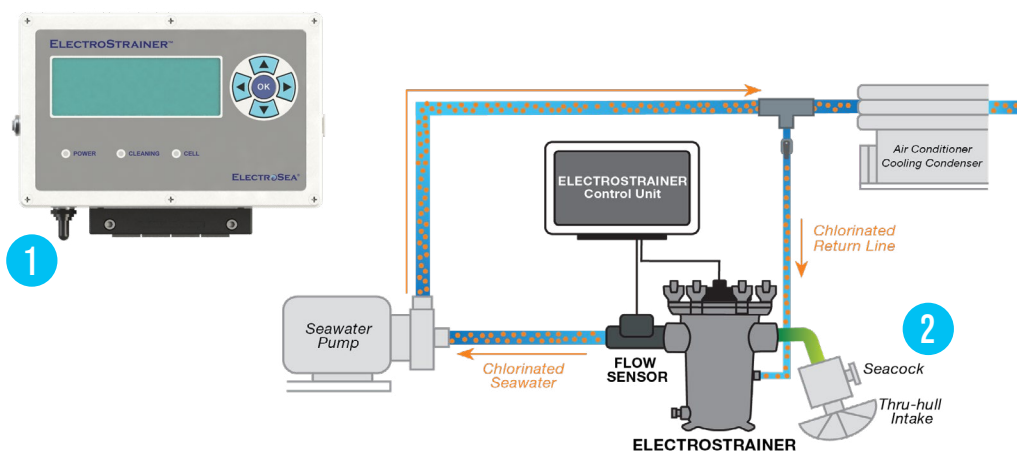



## ElectroStrainer Maintenance

1. Loosen the pressure ring by turning the wing nuts counterclockwise.
2. Remove the pressure ring.
3. Remove the Cell Assembly. Lift straight up by the black plastic cover. Do not lift or pull on the cable. Set the Cell Assembly aside in a safe location.

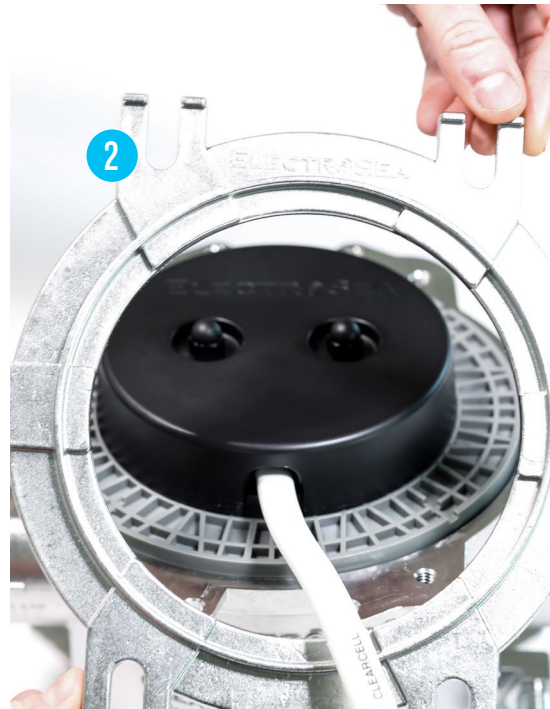
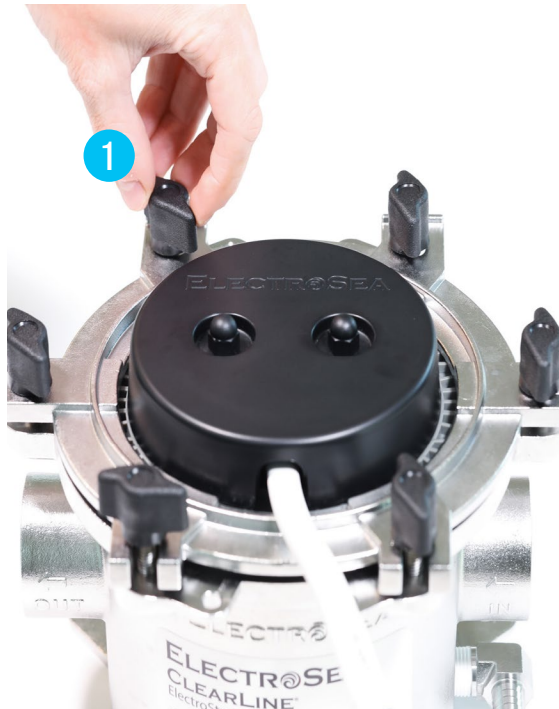

## ElectroStrainer Maintenance

4. Remove the strainer basket from the Canister. Spray the strainer basket with fresh water to remove any mud, seaweed, or debris caught in the strainer pores.
5. Spray the internal surfaces of the Canister with fresh water.
6. After the strainer basket and Canister are clean, place the strainer basket back into the Canister.

**NOTICE** THERE MAY BE NEGLIGIBLE GROWTH AT THE INLET OF THE STRAINER OR INTERIOR OF THE CANISTER. THIS IS NORMAL AS INCOMING SEAWATER IS NOT YET CHLORINATED AND/OR THERE MAY BE AREAS OF LOW CHLORINATION AT CERTAIN FLOW RATES. THIS IS NOT CAUSE FOR CONCERN. ELECTROSTRAINER IS WORKING PROPERLY IF “CLEANING” IS SHOWN ON THE DISPLAY.

**NOTICE** **DO NOT PERFORM ACID DESCALING OF THE SEAWATER CIRCUIT AFTER THE ELECTROSTRAINER SYSTEM HAS BEEN INSTALLED. DESCALING ACIDS OR CLEANING CHEMICALS WILL DAMAGE THE CELL AND CANISTER AND VOID THE WARRANTY.**

**NOTICE** Low seawater flow may damage the cooling system and other components that depend on this water for proper operation. It is the owner's responsibility to monitor the vessel's seawater flow rate and perform any maintenance on the vessel's seawater pumps and strainers.

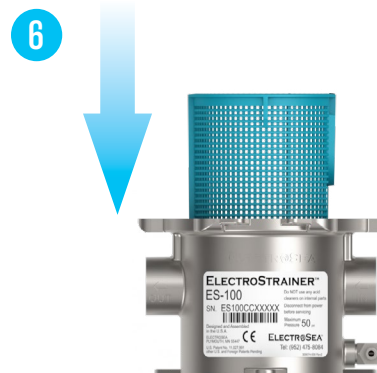
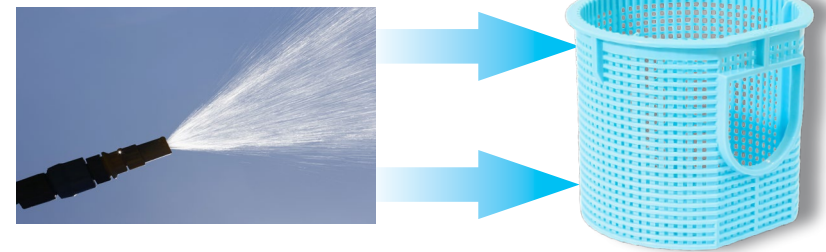

## ElectroStrainer Maintenance

7. Spray the plastic screen that covers the Cell Assembly. If there is excessive mud or debris, the plastic screen can be removed from the Cell. It is NOT necessary to remove the plastic screen from the Cell if debris rinses off and the plastic screen and Cell appear clean.
8. **ONLY if there is excessive mud or debris, remove the plastic screen from the Cell. To separate these components, hold the round black plastic top in one hand and the bottom plastic screen in the other, then pull lightly in opposite directions. The plastic screen will slide apart from the Cell. DO NOT PUSH IN THE SIDE TAB LOCKS, OR THIS WILL MAKE THE PLASTIC SCREEN HARD TO REMOVE. Reassemble the plastic screen on to the Cell after cleaning with fresh water.**



### NOTICE

- **DO NOT PERFORM ACID DESCALING OF THE SEAWATER CIRCUIT AFTER THE ELECTROSTRAINER SYSTEM HAS BEEN INSTALLED.**
- **DESCALING ACIDS OR CLEANING CHEMICALS WILL DAMAGE THE CELL AND CANISTER AND VOID THE WARRANTY.**
- **DO NOT TOUCH THE CELL PLATES OR USE ANY TYPE OF MECHANICAL BRUSH.**
- **THE CELL PLATES CONTAIN A SPECIAL METAL-OXIDE COATING THAT WILL BE PERMANENTLY DAMAGED IF YOU HANDLE IT.**



## ElectroStrainer Maintenance

9. Insert the strainer basket into the Canister. Align the flat edge of the basket with the flat edge of the Canister.
10. Confirm the gasket is in the top of the Canister.
11. The Canister and lid are keyed and can be inserted in only one direction. Align the flat edge of the Cell screen and strainer basket. Make sure the lid key is aligned with the Canister, then insert the Cell Assembly into the Canister.
12. Add the pressure ring to the top of the Canister. Bleed excess air from the Canister, then tighten down the wing nuts evenly. Do not use tools to perform this tightening process. Work in a star pattern so all wing nuts are evenly secure.
13. Double-check that all fittings, hose clamps, and wing nuts are secure. Open the seacock valves and verify there are no leaks.

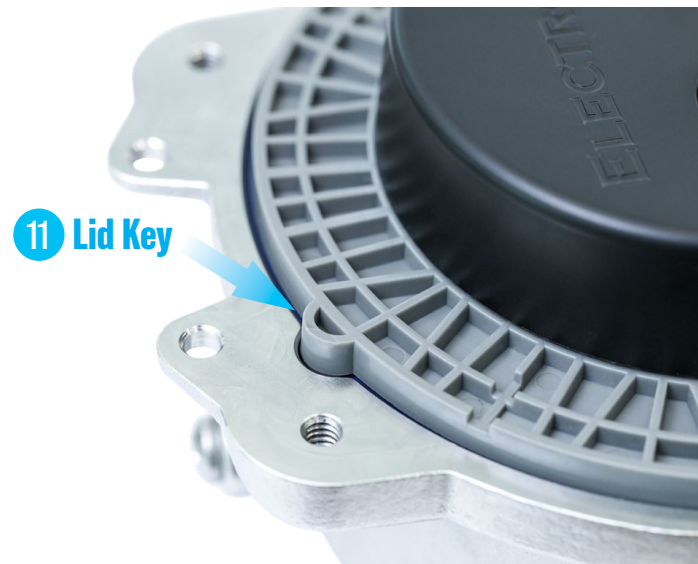

## ElectroStrainer Maintenance

14. Reconnect the Cell Cable between the Control Unit and the Canister.
15. Open the seacocks and check for any leaks.
16. Turn the seawater intake pumps on. The seawater intake pumps must be on and pumping seawater at normal flow rates for the ElectroStrainer System to operate.

**NOTICE** Any air trapped in the Canister must be bled out. Cycle the seawater pump and/or loosen the Canister wing nuts to bleed out excess air, then re-tighten the pressure ring on the Canister.

**NOTICE** DO NOT restrict seawater flow to the ElectroStrainer Canister.

17. Turn ON the ElectroStrainer System on the Control Unit. The Control Unit "CLEANING" LED should be illuminated in green, and the display should state it is Cleaning.

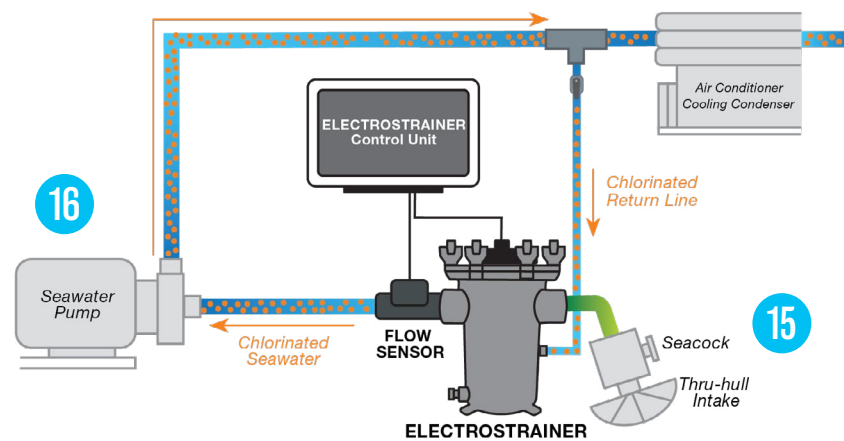
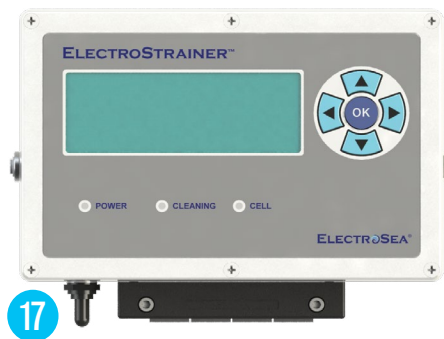

## Cell Indicator

**Cell Indicator:** The Control Unit will display “SALINITY/CELL,” “% OUTPUT,” and illuminate the red Cell LED in various conditions. This is not an immediate cause for concern and may be temporary depending on seawater salinity level. ElectroStrainer will continuously attempt to generate chlorine and automatically resume standard operation when conditions are resolved. The Cell Indicator will be illuminated if any of the following conditions occur for multiple consecutive days:

- Water salinity is below 20 parts per thousand. (This is the most common cause of a Cell Indicator notice.)
- ElectroStrainer Cell Cable or its connectors have been compromised.
- ElectroStrainer Cell has excessive mud or other debris.
- ElectroStrainer Cell is at the end of its useful life.

### Water Salinity

- Vessels often encounter brackish or fresh water when cruising inland or from extended storms and freshwater runoff.
- Low salinity is the most frequent cause of the Cell Indicator.
- ElectroStrainer will not display “CLEANING” or generate chlorine while the vessel is operating in fresh water.

**RESOLUTION:** Return vessel to seawater with adequate salinity.

### ElectroStrainer Cell Cable

- The ElectroStrainer Cell Cable and connections must not be spliced, cut, compromised, or damaged.
- Inspect the Control Unit-to-Cell Cable carefully. Look for any corrosion at the connectors.

**RESOLUTION:** Replace the ElectroStrainer Cell Cable if it is compromised.

### Excessive Mud or Other Debris

- If there is excessive mud or other debris, the ElectroStrainer Cell may require a brief rinse with fresh water.

**RESOLUTION:** Follow instructions on pages 8-13.

### ElectroStrainer Cell at End of Life

- When the ElectroStrainer Cell has reached the end of its useful life, it can no longer generate chlorine. The Cell life is dependent on flow rate, hours of use, seawater quality, and other factors.

**RESOLUTION:** Contact your ElectroSea dealer.

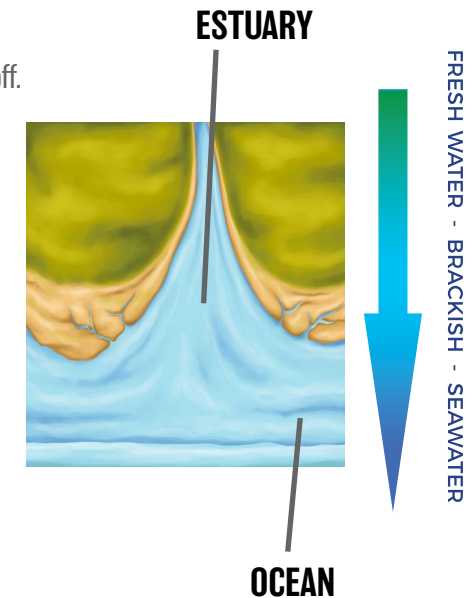

### Factory Default and Firmware Updates

1. **Default:** This is the process to restore ElectroStrainer to its original factory default settings. Press and hold the Up and Down arrows simultaneously for 10 seconds to restore factory default settings.



- 2. **Update:** This allows the user to update the firmware using a USB memory drive supplied by ElectroSea. To perform a firmware update
  - a. Insert the ElectroSea USB memory drive.
  - b. Go to the Update menu. Line 1 displays the current firmware version of the unit. Line 2 displays the available firmware version that is on the USB memory drive. It is possible to upgrade or downgrade the firmware version.
  - c. Press and hold the Up and Down keys simultaneously for 10 seconds, then release the keys once the update begins.
  - d. During the update, the Control Unit is in a locked mode and cannot be used. The bottom line of the display will show the update progress.
  - e. Once the update is complete, the Control Unit will reboot.
  - f. Confirm the update was successful by going back to the Update menu. The display will show the FW X.X is up to date.

**NOTICE** In the event that the firmware update fails, the Control Unit maintains a redundant copy of the existing firmware. The screen will display a result message at the end of an update attempt to confirm the update was successful. Repeat the steps above to retry the firmware update if necessary.

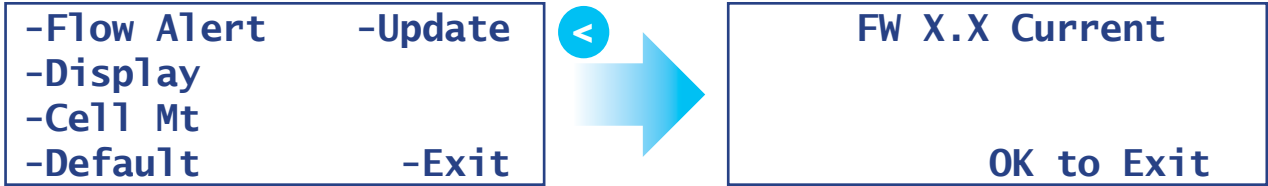

---

## Periodic Inspection

The ElectroStrainer should be viewed during regular inspection of the vessel's engine room. During normal operation, the ElectroStrainer status screen will flash the message "CLEANING," and the green LED will be illuminated. This indicates the ElectroStrainer System is generating a safe and effective low level of chlorine to prevent unwanted marine growth, barnacles, and biofilm in the strainer and seawater lines.

If there are any concerns during the regular inspection noted above, perform a more thorough process:

- Visually inspect all wires and connections between the Control Unit and the Canister Assembly.
- Disassemble the Canister Assembly and thoroughly flush the strainer basket and Cell with fresh water.
- Visually inspect the ClearVis Flow Sensor.
- Visually inspect seawater conduits downstream of ElectroStrainer to confirm marine-growth prevention.

**NOTICE** Inspection and maintenance are the responsibility of the vessel owner.



## Specifications

	ElectroStrainer Model: ES-125	ElectroStrainer Model: ES-100
<b>ElectroStrainer Control Unit Dimensions (L x W x H)</b>	9.96 x 6.75 x 3.25 inches (252.98 x 171.45 x 82.55 mm)	9.96 x 6.75 x 3.25 inches (252.98 x 171.45 x 82.55 mm)
<b>Weight</b>	4 lb 6 oz (1.98 kg)	4 lb 6 oz (1.98 kg)
<b>Power Source</b>	12 or 24 VDC	12 or 24 VDC
<b>Power Consumption</b>	Max Power: 50 watts Typical Power: 20 watts	Max Power: 50 watts Typical Power: 20 watts
<b>Internal Circuit Breaker</b>	10 amps	10 amps
<b>Cables Included</b>	Power: 20' (6.1 m) Cell: 20' (6.1 m) Flow Sensor: 20' (6.1 m)	Power: 20' (6.1 m) Cell: 20' (6.1 m) Flow Sensor: 20' (6.1 m)
<b>ElectroStrainer Canister Dimensions (L x W x H)</b>	8.20 x 7.72 x 6.26 inches (208.28 x 196.00 x 158.89 mm)	8.20 x 7.72 x 6.26 inches (208.28 x 196.00 x 158.89 mm)
<b>Inlet / Outlet</b>	1.25 inches NPT (DN32)	1.0 inch NPT (DN25)
<b>Flow Rate</b>	Optimal Flow: 6-17 gpm Min/Max Flow: 4-30 gpm	Optimal Flow: 3-12 gpm Min/Max Flow: 3-20 gpm
<b>Maximum Operating Pressure</b>	50 psi	50 psi

## Modes, Descriptions and Actions

Mode	Description	Action
<b>OFF</b>	Unit is powered ON, but it is in the OFF state. No seawater is flowing through the system.	This is a normal operating mode, provided there is no seawater flow.
<b>Cleaning</b>	The unit is in the mode for Cleaning and preventing biofouling by chlorinating seawater.	This is a normal operating mode. See page 6 for Cleaning Mode.
<b>Auto</b>	The unit is automatically optimizing the level of chlorinated seawater based on multiple input parameters, including flow rate, key electrical parameters, and environmental temperature.	This is a normal operating mode. See page 6 for Auto Mode.
<b>Min Flow</b>	The flow rate is 1-3 GPM (3.8-11.4 LPM) and is too low to chlorinate seawater.	The Min Flow indicator will disappear when the seawater flow rate is >4 GPM (15.1 LPM).
<b>No Flow</b>	The flow rate is 0 GPM.	The No Flow indicator will disappear when the seawater flow returns.
<b>Strainer Flow Alert</b>	Strainer Flow Alert is a user-defined threshold value for visual alert and notification purposes to indicate there may be debris in the strainer basket and/or the flow rate is below a threshold for a period of time. The user should manually set the desired Strainer Flow Alert value and time duration.	<p>ElectroStrainer will continue generating chlorine even after a Strainer Flow Alert occurs. <b>Note:</b> If the flow rate is less than or equal to 4 GPM (15.1 LPM), then a Min Flow alert will occur, and ElectroStrainer will stop chlorinating seawater. If a Strainer Flow Alert occurs</p> <ol style="list-style-type: none"> <li>1. Check vessel's strainers and intake grates for blockage.</li> <li>2. Check seawater pump operation.</li> <li>3. Check all other components in the seawater intake fluid path.</li> <li>4. Check Canister Assembly and rinse strainer basket according to the instructions starting on page 8.</li> </ol>

## Modes, Descriptions and Actions

Mode	Description	Action
<p><b>Cell Indicator</b></p>	<p>The Control Unit will display “SALINITY/CELL,” “% OUTPUT,” and illuminate the red Cell LED in various conditions. This is not an immediate cause for concern and may be temporary depending on seawater salinity level. ElectroStrainer will continuously attempt to generate chlorine and automatically resume standard operation when conditions are resolved.</p>	<p><b>Water Salinity</b></p> <ul style="list-style-type: none"> <li>Vessels often encounter brackish or fresh water when cruising inland or from extended storms and freshwater runoff.</li> <li>Low salinity is the most frequent cause of the Cell Indicator.</li> <li>ElectroStrainer will not display “CLEANING” or generate chlorine while the vessel is operating in fresh water.</li> </ul> <p><b>RESOLUTION: Return vessel to seawater with adequate salinity.</b></p> <p><b>ElectroStrainer Cell Cable</b></p> <ul style="list-style-type: none"> <li>The ElectroStrainer Cell Cable and connections must not be spliced, cut, compromised, or damaged.</li> <li>Inspect the Control Unit-to-Cell Cable carefully. Look for any corrosion at the connectors.</li> </ul> <p><b>RESOLUTION: Replace the ElectroStrainer Cell Cable if it is compromised.</b></p> <p><b>Excessive Mud or Other Debris</b></p> <ul style="list-style-type: none"> <li>If there is excessive mud or other debris, the ElectroStrainer Cell may require a brief rinse with fresh water.</li> </ul> <p><b>RESOLUTION: Follow instructions on pages 8-13.</b></p> <p><b>ElectroStrainer Cell at End of Life</b></p> <ul style="list-style-type: none"> <li>When the ElectroStrainer Cell has reached the end of its useful life, it can no longer generate chlorine. The Cell life is dependent on flow rate, hours of use, seawater quality, and other factors.</li> </ul> <p><b>RESOLUTION: Contact your ElectroSea dealer.</b></p>
<p><b>High Temperature</b></p>	<p>ElectroStrainer internal temperature is high.</p>	<p>Contact your ElectroSea dealer or ElectroSea directly as the Cell may be at the end of its useful life.</p>

---

**ELECTROSEA<sup>®</sup>**



(888) 384-8881  
(952) 475-8084



support@electrosea.com  
www.electrosea.com